



GE AC/DC SiC-RS

4 Quadrant Regenerative AC Grid Simulator
Regenerative DC Bidirectional Source and Sink

Meticulously designed for R&D, validation,
and End-of-Line testing



Electromobility

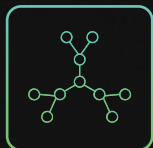

Smart Grids



Photovoltaic

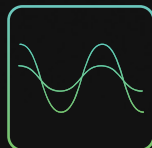

Academic &
Industrial Test



Power HIL



Energy Storage
System

GE AC/DC SiC-RS

4 Quadrant Regenerative AC Grid Simulator Regenerative DC Bidirectional Source and Sink

This innovative high-efficiency converter has been meticulously designed for R&D, validation and EoL testing in the fields of electromobility and EV charging infrastructure, V2G, smart grids, distributed energy resources, Power HiL, battery inverters, energy storage systems and aerospace.

As the first member of our new Rack Series (RS) family, the GE AC/DC SiC-RS sets a new standard for performance, reliability and quality. Harnessing the power of cutting-edge SiC technology, it features lower switching losses and reduced size and weight, making it an ideal solution for applications where space and efficiency are critical.

Regenerative Technology

Like all CINERGIA products, the GE AC/DC SiC-RS allows for the reinjection of used power back to the grid, resulting in a reduction of both consumed energy and required power contributing to a smaller carbon footprint.

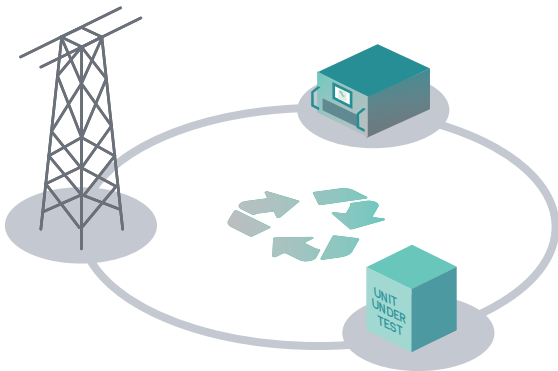

The Highest Efficiency

Our Rack Series offers the highest efficiency on the market for both sourcing and regenerating energy, resulting in greater energy savings and a reduction in electrical installation rating.

Functionalities

The GE AC/DC SiC-RS may be used as an AC Grid Simulator, DC Bidirectional source/sink, Power Amplifier, Battery Tester, Cycler and Emulator, or PV Panel Emulator.

Made in Europe

SiC-RS family products are fully designed and manufactured in Europe, subject to the most rigorous testing, complying with CE marking, safety, EMC and ISO 9001 quality standards.

SiC Technology

High performance and efficiency

User Friendly Interface

Designed by engineers for engineers

Larger Touchscreen

7-inch display for easy local operation

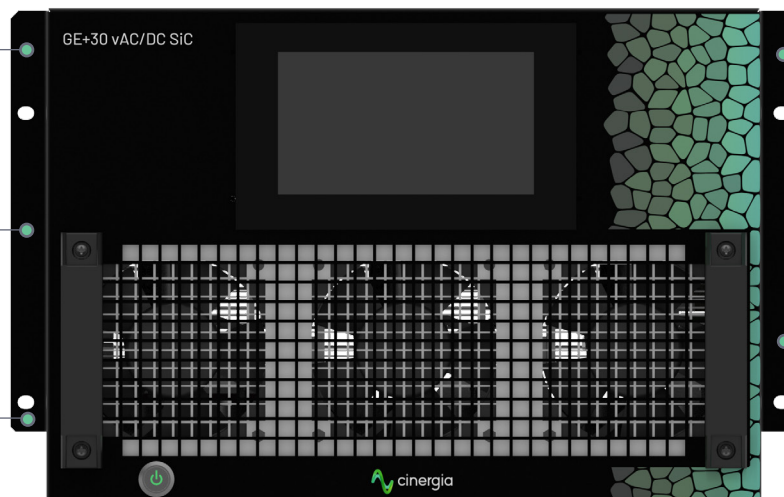

19-inch Rack format

With 30 kW in a 7U and 675mm depth unit, it can be easily mounted into standard 19-inch rack cabinets

Easy Integration

Analog & digital IO and the open MODBUS/TCP protocol are provided for seamless integration into automated test lines

Main features

19-inch rack format

30 kW in a 7U and 675mm depth unit, designed for 19-inch rack cabinets

The cumulative expertise of CINERGIA has been condensed into this compact unit that simultaneously excels in robustness, efficiency and cutting-edge technology for optimal performance.

The compatibility of the Rack Series with universal rack cabinets sets a new standard for space efficiency, modularity, and scalability, resulting in high versatility and easy integration into a comprehensive testing environment.

Easy Integration

Analog & digital IO and the open MODBUS/TCP protocol are provided for seamless integration into automated test lines.



Larger Touchscreen

Enjoy seamless functionality directly at your fingertips

Local control of the unit is easier than ever with the new 7-inch display, the bigger and brighter of its kind:

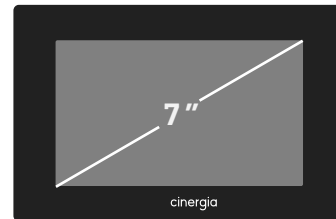

The LCD provides access to all functionalities of the unit without the need of a computer or ethernet connection: start/stop/reset, channel configuration, running test sequences, plotting and datalogging.

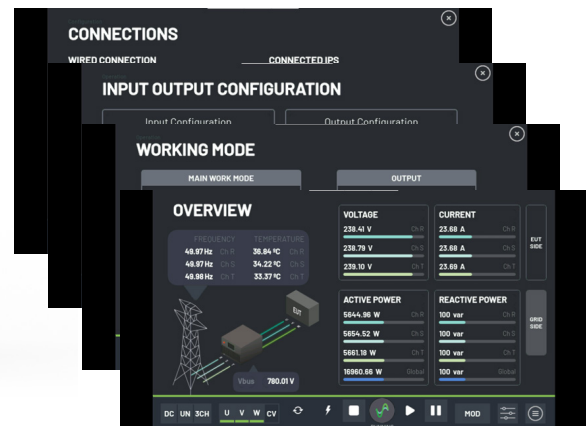

SiC Technology

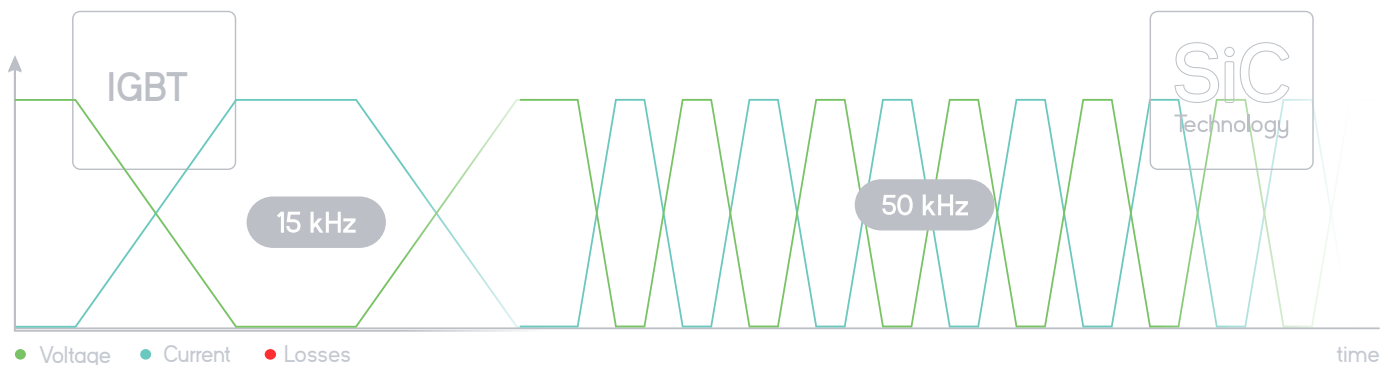

Transitioning to SiC technology results in an increased switching frequency of the converter, which translates into higher dynamics, faster transients and enhanced performance, making it the perfect candidate for EoL environments, R+D, Validation and Power Hardware in The Loop (PHIL) testing.

The faster switching time of the SiC MOSFETS reduces the current-voltage crossover duration, and therefore the losses at each commutation, improving overall efficiency.

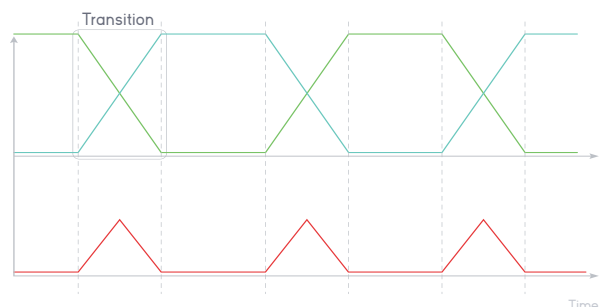

High Efficiency

Our Rack Series offers the highest efficiency on the market for both sourcing and regenerating energy, resulting in greater energy savings and a reduction in electrical installation rating.

- **Cost Savings:** Significantly lower electricity bills thanks to minimal energy losses.
- **Heat Dissipation:** Less excess heat generation simplifies thermal management.
- **Environmental Impact:** Reduced carbon footprint due to minimized energy waste and power reinjection
- **Optimized Facilities:** Lower current drawn reduces wire size requirements and CAPEX needs.
- **Regenerative Technology:** The GE AC/DC SiC-RS reinjects energy back to the grid, cutting down on overall consumption and power needs.



Bidirectional and Regenerative Hardware

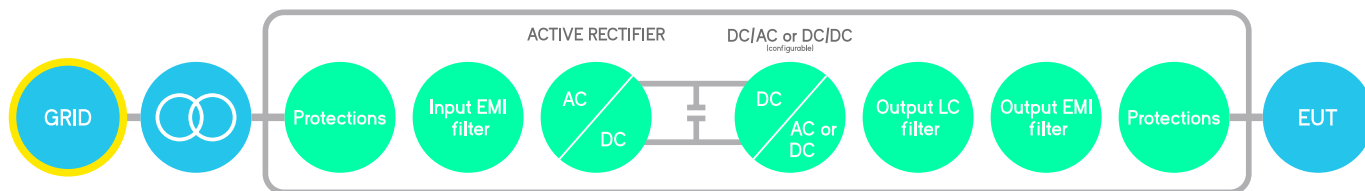

The hardware platform is built on a Back-to-Back power conversion topology, based on SiC MOSFETs transistors. The grid side stage is an Active Rectifier which produces clean sinusoidal currents with very low harmonic distortion and power factor close to one.

The EUT side output can be configured for AC voltage source or DC output. In AC, voltage is controlled by using state of the art digital Proportional Resonant controllers. In DC, the three independent buck-boost bidirectional legs enable the separated control of three DC voltages or currents.

Block Diagram

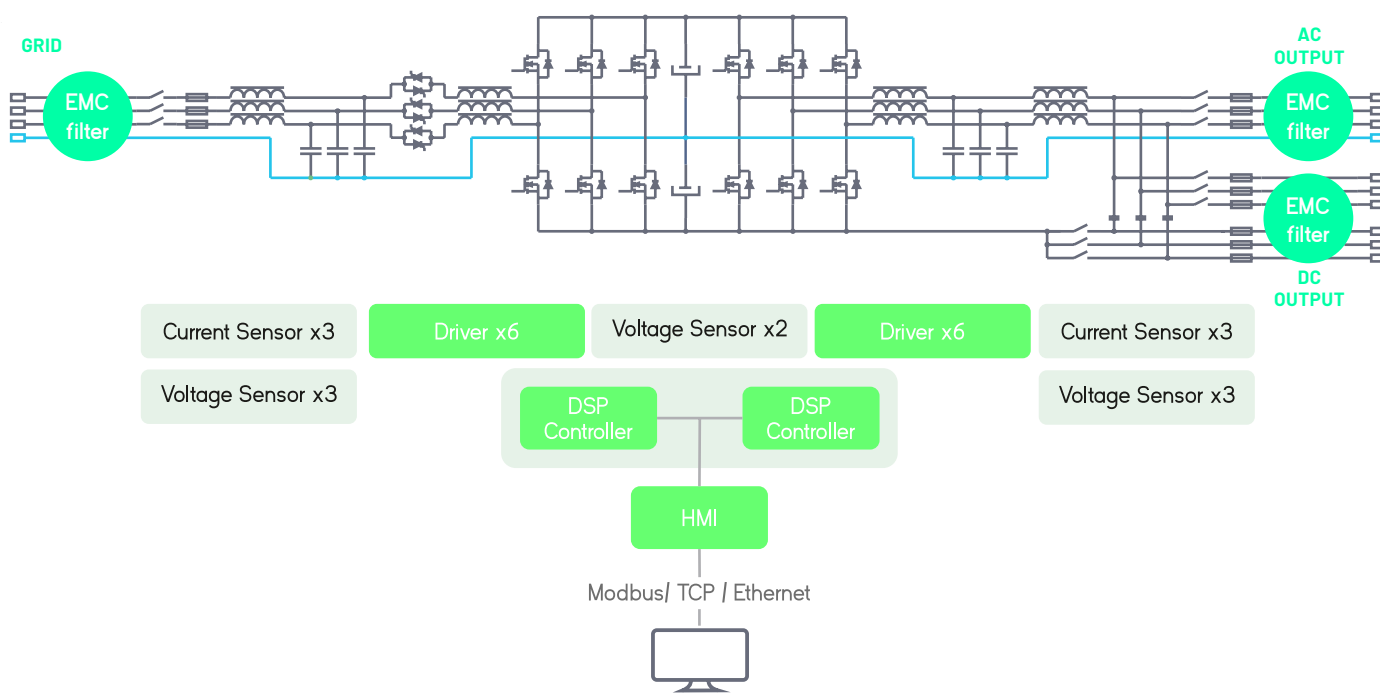

User Interface



Designed by Engineers for Engineers

CINEINA is the software user interface supplied with every CINERGIA device, fully developed by our R&D team to provide full control over the unit.

Its intuitive and user-friendly design allows to effortlessly use the device's multiple functionalities, ensuring a minimal learning curve for both new and experienced users.



Features



Supervision

The Supervision tab offers comprehensive oversight of the unit's operation. All data is logged and graphed to monitor performance and ensure optimal functionality.

The Supervision window can be undock into a different screen for better overall control.

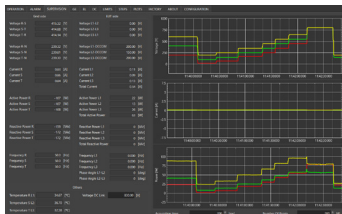

Plots

Record and track the unit's operation during testing with the Plots tab. This function is embedded in the unit and does not require any external devices or an internet connecton.

All activity data is saved in convenient .csv files, ready for immediate plotting or download for later in-depth analysis.

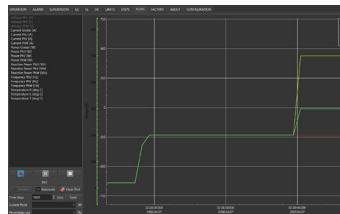

1 Channel Mode

The device can be controlled in 1 Channel mode where the 3 output phases are internally short-circuited, in order to be suitable for single-phase applications.

Contact us for power derating in AC 1 Channel Mode. No power derating in AC 3 Channel or DC.

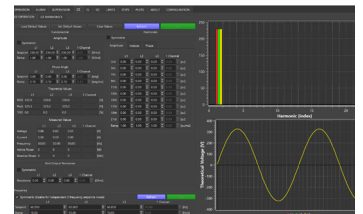

AC



AC Operation

Each phase can be independently configured: RMS voltage, frequency, phase delay, harmonics distortion, as well as the ramps associated with each mentioned variable. The expected waveform is plotted, the FFT is represented and the numeric data shown: RMS, peak, CF and THD.

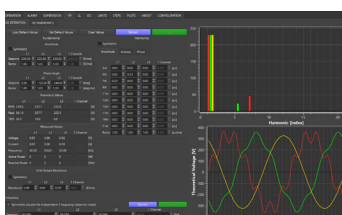

Harmonics

The CINEINA software allows the generation of sub-harmonics, interharmonics and high frequency harmonics up to the 50th, setting both magnitude and phase delay. Harmonic sequences can be saved and loaded as .csv files to ease testing standarization.



Disturbance Generation

The AC fault panel is a powerful yet intuitive editor which allows generation of distorted waveforms: flicker, voltage dip, frequency and voltage variations... Specific profiles can be saved in .csv files, modified and reused by importing an existing one.

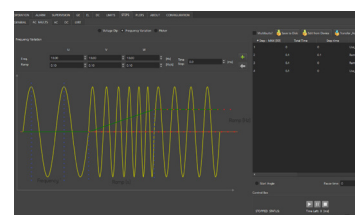

DC



DC Operation

The DC Unipolar/Bipolar panel is where the setpoints and limits are defined. Each of the 3 channels can work simultaneously in a different Operation Mode: Voltage, Current, Power, Resistance, Battery Test, Emulation, PV Emulation... Transition ramps, voltage and current limits can be adjusted individually to ensure safe testing, particularly in battery applications.

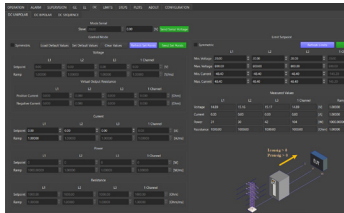

Sequence

CINEINA includes a Test Editor with the purpose of designing and/or importing automated sequence tests, which can later be exported as .csv files.

A smart datalogger can be set to automatically save voltage, current and power measurements with a 400ms time resolution.

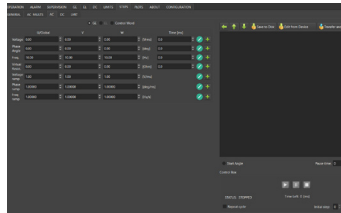

Multichannel

Enabling the Separated Channel Control converts the device in three functionally independent DC Bidirectional Power Supplies, sharing the common negative rail. Each channel can have a different status (ON, OFF, Warning, Alarm), Operation Mode (see Range and Specifications table), Setpoint, Ramp and Limits.

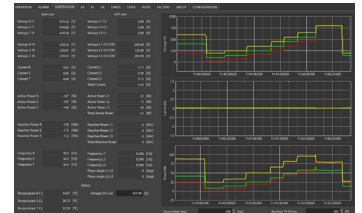

Battery Pack Tester

An integrated software designed for testing charge/discharge battery cycles. Thanks to the Multichannel, 3 batteries or battery packs can be tested simultaneously. Test parameters such as charge/discharge current, float, boost voltage, number of cycles... can be adjusted for monthslong tests.

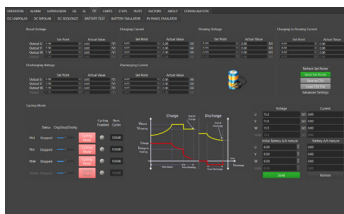

Battery Emulation

The unit incorporates a mathematical model in order to emulate the behaviour of real batteries or battery packs. Defining the characteristic parameters enables the simulation of different battery technologies (Lilon, NiMH, NiCd, Pb...).

All within one unit!

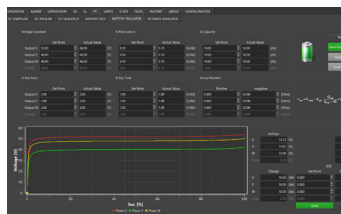

PV Panel Emulation

Based on a single-diode equivalent circuit, the PV Emulation mode allows the virtual simulation of solar arrays. The PV Panel characteristic parameters, string configuration, irradiance and temperature values can be defined or exported from a .csv file for flexible testing.

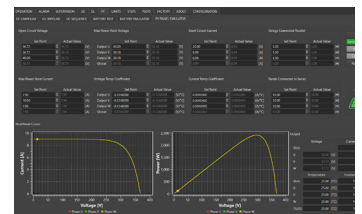

Range & Specifications

Input side (GRID side)

AC Voltage

Rated: 3x400 Vrms +Neutral+ Earth (5 wires)

Optional 3x480 Vrms (4 or 5 wires)*

Rated AC Current

< 48 A/phase (@rated conditions)

Frequency

47-63 Hz

Current Harmonic Distortion

THDi <2% at rated power

Power Factor

PF>0.98 at rated power

Efficiency

>93,5% (@rated conditions)

*This option will add the IT-RS transformer.

Output side GE AC (EUT side)

Terminals

Number: 4 (3 phases + neutral)

Configuration of Channels

3 Channel: 4 Quadrants, independent setpoints per phase

1 Channel: 4 Quadrants, single setpoint (with power derating)

Multichannel: 4 Quadrants, independent start/stop/reset, alarm status, ramps and setpoints per phase

Voltage Mode (CV)

Peak: ± 420 V phase-neutral

Range: 0⁽¹⁾ to 295 Vrms phase-neutral

0⁽¹⁾ to 510 Vrms phase-phase

THDv: < 0.2% rated linear load at 230 Vrms (40 Hz to 100 Hz)

Setpoint Resolution: 10 mVrms

Effective Resolution⁽²⁾: < 0.05% of FS⁽³⁾

Setpoint Accuracy⁽⁴⁾: $\pm 0.1\%$ of FS⁽³⁾

Transient Time⁽⁵⁾: < 100 μ s (10% to 90% of 230 Vrms)

Slew Rate: Configurable, Max 2,5 V/ μ s

Ripple: ≤ 0.5 Vrms (with probe bandwidth <250 kHz)

Harmonics Range

Range: up to 5 kHz (up to 50th harmonic)

50 independent harmonics per phase:

21 free programmable frequency and phase from 0.1 to 50 times fo

29 fixed frequency

Harmonics content: $V \cdot f < 180000$ V·Hz

Frequency

Fundamental Frequency Range: 10 to 400 Hz

Small Signal Bandwidth: up to 5000 Hz

Resolution: 1 mHz

Phase Angle

Range: 0 to 360 °

Resolution: 0.01 °

Output side in DC (EUT side)

Terminals

Number: 6 (3 positive + 3 negative)

Configuration of Channels

Unipolar:

3 Channels: 2 Quadrants, independent setpoints per channel

1 Channel: 2 Quadrants, single setpoint

Bipolar: 4 Quadrants, two independent setpoints

Multichannel: 2Q, independent start/stop/reset, operation mode and setpoints per channel

Voltage Mode (CV)

Range: 2 Quadrants: 0⁽¹⁾ to 800 V (Unipolar configuration)

4 Quadrants: ± 380 V to ± 380 V (+ rail / 0 / - rail, Bipolar configuration)

Setpoint Resolution: 10 mV

Effective Resolution⁽²⁾: < 0.05% of FS⁽³⁾

Setpoint Accuracy⁽⁴⁾: $\pm 0.1\%$ of FS⁽³⁾

Transient Time⁽⁵⁾: < 250 μ s (10% to 90% of Vrated)

Ripple⁽⁷⁾: < 2 Vpp (with probe bandwidth <250 kHz)

Current Mode (CC)

Range: from 0 to $\pm 110\%$ of Irated

Setpoint Resolution: 10 mA

Effective Resolution⁽²⁾: < 0.05% of FS⁽³⁾

Setpoint Accuracy⁽⁴⁾: $\pm 0.2\%$ of FS⁽³⁾

Power Mode (CP)

Range: from 0 to $\pm 110\%$ ⁽⁸⁾ of Prated

Derived current setpoint: Psetpoint / Vmeasured

Setpoint Resolution: 1 W

Effective Resolution⁽²⁾: < 0.1% of FS⁽³⁾

Setpoint Accuracy⁽⁴⁾: $\pm 0.4\%$ of FS⁽³⁾

Resistance Mode (CR)

Range: from 0.1 to 1000 Ohm

Derived current: Vmeasured / Rsetpoint

Setpoint Resolution: 0.01 Ohm

Setpoint Accuracy⁽⁴⁾: $\pm 0.2\%$ of FS⁽³⁾

Overload/ Overcurrent

Admissible AC overcurrent and overload:

115% of rated value during 10 minutes,
120% during 1 minute, 130% during 2 seconds

Admissible DC overcurrent and overload:

110% during 1 minute

Operation Modes

AC

Programmable Constant Voltage (CV)
Steps

DC

Programmable Constant Voltage (CV)
Programmable Constant Current (CC)
Programmable Constant Power (CP)
Programmable Constant Resistance (CR)
Steps

Optional Battery Testing (BTest) (charge/discharge/cycling)

Optional Battery Emulation (Bemu)

Optional PV Panel Emulation (PVEmu)

Power Hardware In the Loop

Power Amplifier (PHIL)

AC or DC Power Amplifier

Delay Analog Input to Real Power Output: 150 μ s

Delay Real Power Output to Analog Output Signal: 130 μ s

* Delay time calculated working in AC configuration.

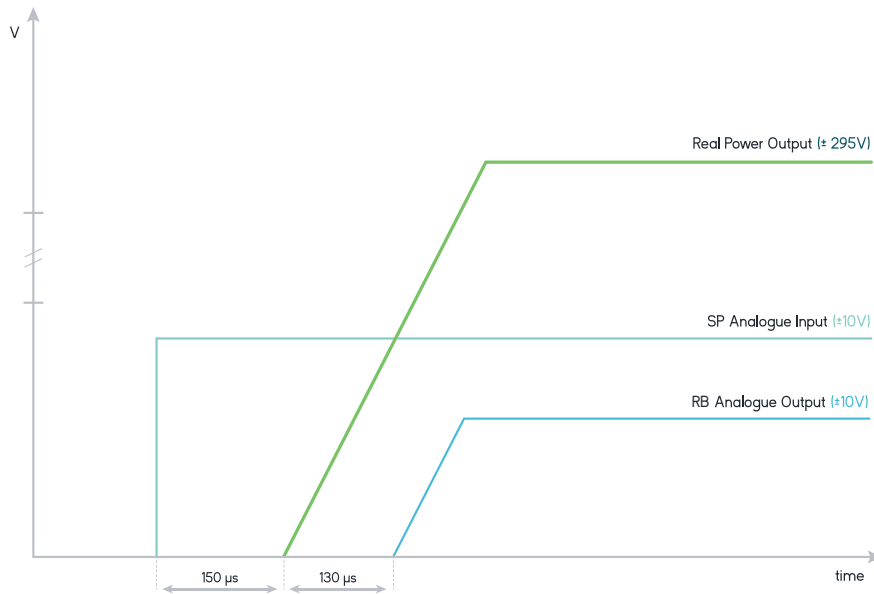

User Interface

Local Control

- 7" Touchscreen panel
- Isolated Digital I/O (DB15):
6 inputs, 4 outputs
- Isolated Analog I/O (BNC):
6 inputs (rms setpoints or power amplifier),
6 outputs (rms readback or real-time readback)
- Emergency Stop port: 1 NC Input

Remote Control Port

- LAN Ethernet with Open Modbus-TCP protocol

Software

- Graphical User Interface for Windows 7/10/11
- LabView drivers and open Labview interface example

Master/Slave Operation

- Connection: fiber optics link (x6)
- Configuration: from software user interface/MODBUS up to 8 units:
AC: Parallel
DC: Parallel, serial or serial-parallel

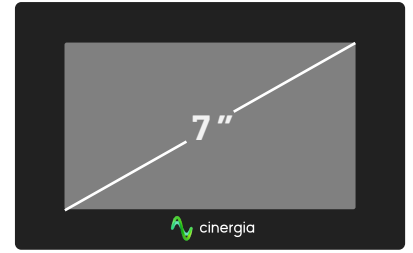

Size and Weight

Height

- 7U (310 mm)
12,20"

Width

- 440 mm
17,30"

Depth

- 675 mm
26,60"

Weight

- 50 kg
110.23 lbs

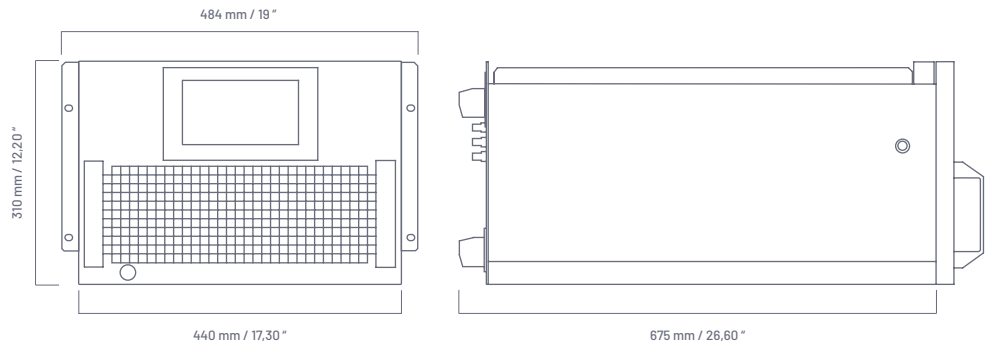

Connections

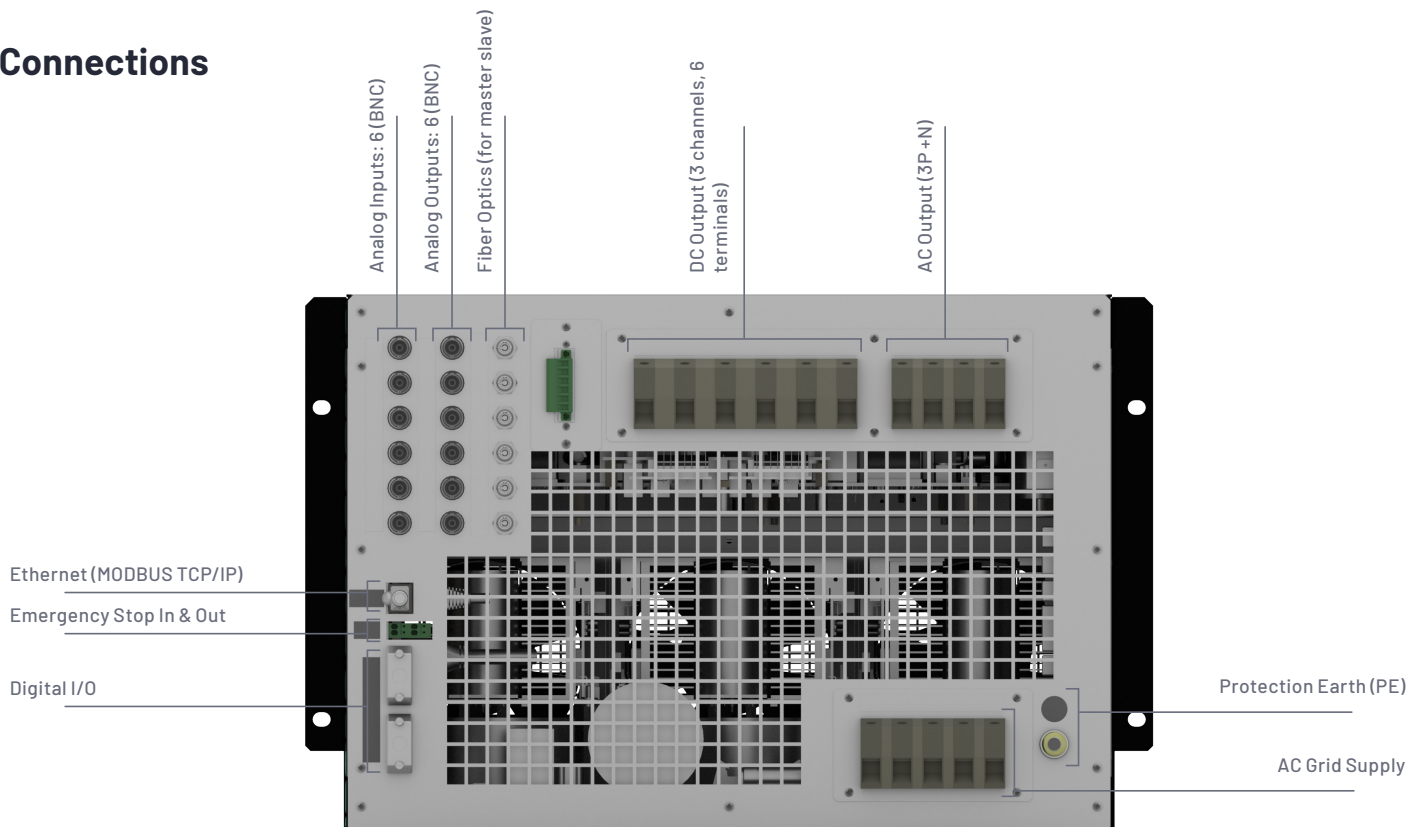

Protections

Overvoltage (peak, rms), Overcurrent (peak, rms), Overload, Shortcircuit, Emergency Stop, Watchdog, Heart Beat, Output Contactor, Wrong Configuration
Alarms and Limits are user configurable and can be saved in a password protected EEPROM

Mesurements ⁽⁶⁾

GRID: Voltage (rms), Current (rms), Active and Reactive Power (P,Q) and Frequency
EUT: Voltage (rms), Current (rms), Active and Reactive Power (P,Q), Frequency and Phase Angle
Heatsink Temperatures and DC Link Voltage
Datalogging available through FTP connection

Ambient

Operating temperature⁽⁶⁾: 5-40°C
Relative Humidity: up to 95%, non-condensing
Cooling: Forced air
Acoustic noise at 1m: <55 dB

Standards

CE Marking
Operation and Safety: IEC 61010-1
EMC: EN-61326-1
RoHS, REACH

All specifications are subject to change without notice.

All specifications are subject to change without notice.

1. Working at low voltages is possible but ripple requirements must be checked, specially in DC
 2. Effective resolution measured with a 400 ms window
 3. FS is defined by the range of the unit, including overcurrent and overload when applicable
 4. Accuracies are valid for settings above 10% of FS
 5. Measured with the rated resistive load and high-dynamics controllers configuration. Adjustment of controllers may be necessary to reduce oscillations in some applications, e.g high capacitance
 6. Accuracy of measurements is $\pm 0.1\%$ of FS for rms voltage, $\pm 0.2\%$ of FS for rms current, $\pm 0.4\%$ of FS for active power (valid only above 10% of FS)
 7. Measured at 400 V under resistive load
 8. Rated power figures are given at 25 °C, power derating applies at higher temperature
 9. The maximum output voltage depends on frequency following $V \cdot f < 180000$ V·Hz
-

GE AC/DC SiC-RS

Reference	AC Power 3phase* Rated	AC Current RatedRMS Per channel	DC Power Rated	DC Current Rated Per channel	Weight (kg) (lbs)	Dimensions DxWxH (mm) (inch)
GE 30 AC/DC SiC-RS	30 kVA/kW	44 Arms	30 kW	±44A	50 kg 110.23 lbs	675 x 440 x 310 mm (7U) 26.57 x 17.32 x 12.20 "

(*) Consult us for derating in AC 1 Channel mode, derating applies

Isolation Transformer RS

Reference	AC Power 3phase Rated	Weight (kg) (lbs)	Dimensions DxWxH (mm) (inch)
IT30-RS**	34 kVA/kW	180 kg 396.83 lbs	710 x 440 x 210mm (5U) 27.95 x 17.32 x 8.28 "

(**) Transformers with Star-Star (Y-Y) or Delta-Star (Δ-Y) configuration are available.

All specifications are subject to change without notice.

Channel Configuration in GE

3 Channels
* 1 Channel

Channel Configuration in DC

3 Channels
1 Channel
Unipolar
Unipolar
Bipolar

Configuration Modes

GE AC
PHiL AC
DC
PHiL DC

Master / Slave

Parallel in AC mode
Parallel
Serial
Serial Parallel in DC mode

Talk directly with our engineers.

✉ sales@cinergiapower.com

☎ +34 934 864 358

🌐 www.cinergiapower.com

Can Baletes 7, Nau A
08310 Argentona
Barcelona (Spain)
Follow us on:
Youtube, LinkedIn, Twitter

Scan the QR code to view the complete datasheet



Regenerative
Power Electronic
Solutions